

LÍNEA FIT

ufficio UFFICIO[®]
EQUIPAMIENTOS





FIT

La movilidad y la versatilidad se combinan para proporcionar soluciones dinámicas para entornos colectivos. La línea permite una fácil reconfiguración de espacios, de forma rápida y eficiente.





La línea consta de sofás y otomanas que se pueden combinar en innumerables diseños, formando espacios de colaboración versátiles y creativos.



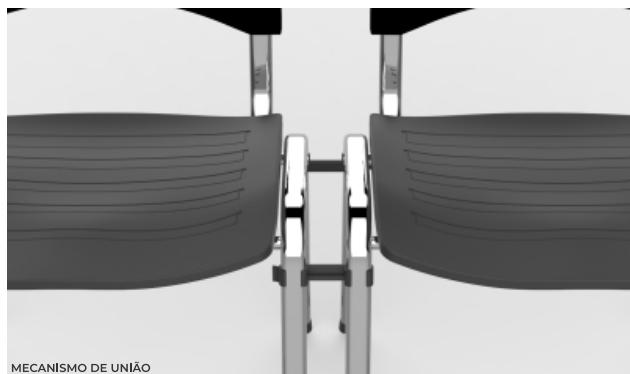

DESENHOS TÉCNICOS | DISEÑOS TÉCNICOS

ASSENTOS

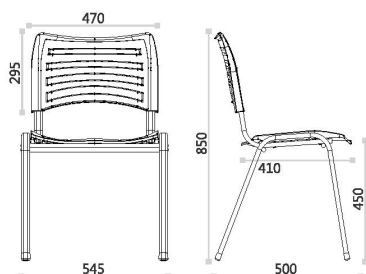

FIT 4 PÉS
EMPILHÁVEL

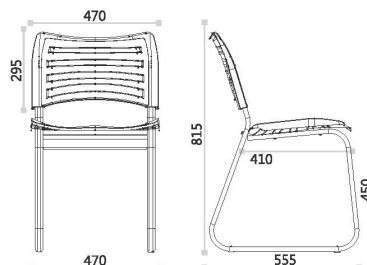

FIT TRAPÉZIO

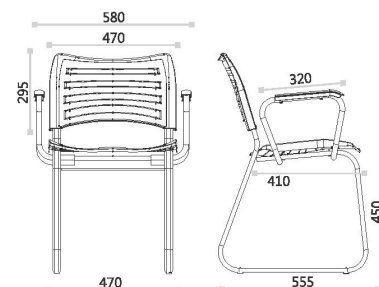

FIT TRAPÉZIO C/BRAÇO

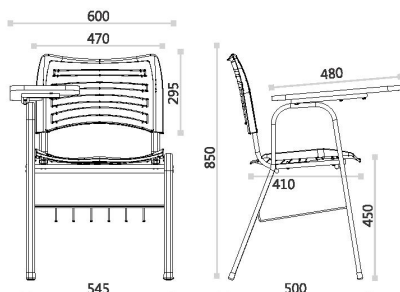

FIT UNIVERSITÁRIA
PRANCHETA FIXA
*LADO DIREITO / LADO ESQUERDO

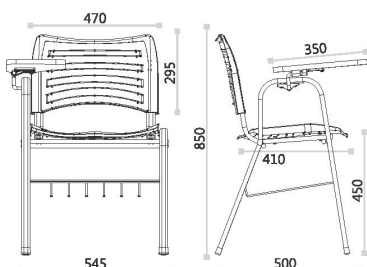

FIT UNIVERSITÁRIA
PRANCHETA ESCAMOTEÁVEL
*LADO DIREITO / LADO ESQUERDO

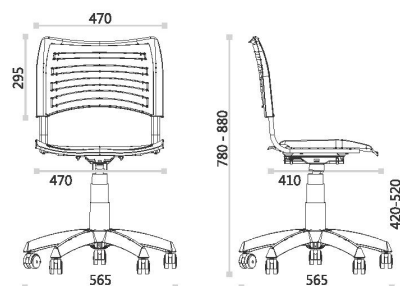

FIT GIRATÓRIA

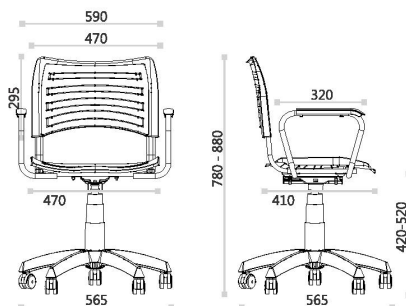

FIT GIRATÓRIA COM BRAÇO

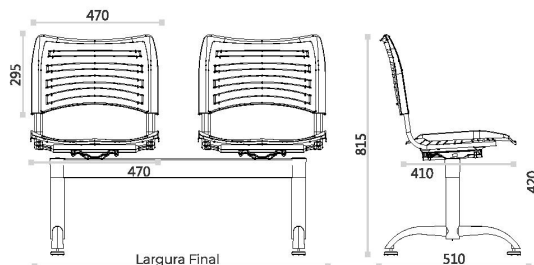

FIT LONGARINA CELTA

LARGURAS
2L - 1090mm 3L - 1710mm
4L - 2330mm 5L - 2950mm

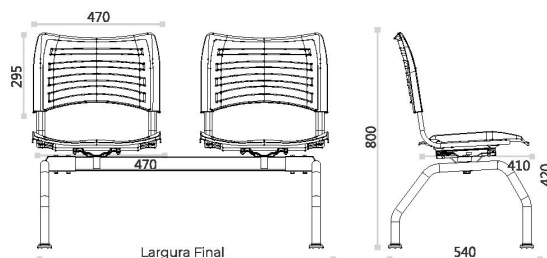

FIT LONGARINA ARKO

LARGURAS
2L - 1090mm 3L - 1710mm

*TAMANHOS DIFERENTES SOB CONSULTA
**MEDIDAS EM MILÍMETROS (largura x profundidade x altura)

ACABAMENTOS | ACABADOS

ESTRUTURA METÁLICA



PLÁSTICO

